



O & M Manual



Chlorlog

Model A22/62

Free Chlorine Data Logger

Home Office

Analytical Technology, Inc.
6 Iron Bridge Drive
Collegeville, PA 19426
Phone: 800-959-0299
610-917-0991
Fax: 610-917-0992
Email: sales@analyticaltechnology.com
Web: www.Analyticaltechnology.com

European Office

ATI (UK) Limited
Unit 1 & 2 Gatehead Business Park
Delph New Road, Delph
Saddleworth OL3 5DE
Phone: +44 (0)1457-873-318
Fax: + 44 (0)1457-874-468
Email: sales@atiuk.com

Table of Contents

PART 1 - INTRODUCTION	4
1.1 General.....	4
1.2 Typical Installation	6
1.3 <i>ChlorLog</i> System Specifications	7
1.4 <i>ChlorLog</i> Sample Requirements.....	7
PART 2 – SENSOR PREPARATION.....	8
2.1 Chlorine Sensor Preparation	8
PART 3 – OPERATION.....	10
3.1 General.....	10
3.2 Startup	10
3.3 Calibration	11
3.4 Adjusting Zero.....	12
3.5 pH Effects on Data.....	12
3.6 Flowcell Orientation	13
PART 4 – DATA HANDLING	14
4.1 General.....	14
4.2 Software Download.....	14
4.3 Configuring the Logger	14
4.4 Downloading Data	19
PART 5 – MAINTENANCE	20
5.1 Batteries	20
5.2 Sensor Maintenance.....	20
5.3 Cover O-ring	20
5.4 Flow Cell Maintenance	21
PART 6 – TROUBLESHOOTING	22
6.1 General.....	22
6.2 Verify Sensor Polarization	22
6.3 Verify Temperature Element.....	23
6.4 Electrode Leakage Test.....	24
SPARE PARTS	25

Table of Figures

<i>Figure 1 - Typical ChlorLog Monitoring Installation.....</i>	<i>6</i>
<i>Figure 2 - Cl2 Sensor Assy (ATI-0294).....</i>	<i>8</i>
<i>Figure 3 - Typical Free Cl2 Response to Change in pH</i>	<i>12</i>
<i>Figure 4 - Pt100 RTD Table.....</i>	<i>24</i>

Part 1 - Introduction

1.1 General

The *ChlorLog* is a compact device designed for temporary measurement and data logging of residual chlorine in potable water systems. Also designated as model A22, this instrument is a unique combination of free chlorine sensor, battery-powered amplifier, and battery-powered data logger integrated into one assembly. The measurement and data logging unit fits into a clear acrylic sample flowcell and can be used to collect chlorine data for up to 6 months.

There are 3 different versions of the *ChlorLog*, one for free chlorine, one for combined chlorine (for chloraminated water), and one for total chlorine. **This manual covers the free chlorine version only.**

The basic sensing element used in the *ChlorLog* is a polarographic membrane sensor which measures chlorine directly. Water simply flows past the sensor and directly to drain. The flowcell used with the A22 contains a fixed-flow regulator that maintains flow at a constant 4 GPH (0.25 LPM). Sample inlet pressure must be limited to a maximum of 60 PSIG (4 Bar). For measurement from high pressure water lines, a pressure reducing valve must be installed ahead of the *ChlorLog*.

The A22 operates on three ½ AA lithium batteries, and will run continuously for approximately 6 months in low power mode. Actual battery life will vary depending on the temperature in which the unit is operating. Cold temperature conditions will decrease battery capacity.



Warning: If unit is to be stored for more than 3 months, **REMOVE** the batteries from the instrument to avoid potential damage from battery leakage and to extend battery life. Always turn display off when storing for any length of time.

ChlorLog units are supplied in a foam lined carrying case with all accessories required to operate the unit for 1-2 years (except for batteries). For sample and drain connections, ¼" O.D. poly tubing is recommended. The carrying case measures 15"x11.5"x5" (38x29x13 cm).

**Contents:**

ChlorLog Data Logger.

Flowcell.

Sample & Drain tubes with
valved fittings.

½ AA Lithium batteries (3).

Calibration tool.

Computer to Logger Cable.

Membranes (pkg. of 10).

Electrolyte (120 ml.)

O-ring kit.

Accessory fittings.

1.2 Typical Installation

The ChlorLog is normally connected to a potable water line as shown in Figure 1 below. As noted previously, the pressure reducing valve is needed if supply water line pressure is higher than 60 PSI (4 Bar). The flowcell is equipped with quick-connect fittings on both the inlet and outlet. A short length of tubing is supplied for each connector.

Note that connectors have integral valves. When disconnected, the flow chamber will remain full of sample water which keeps the sensor in good operating condition.

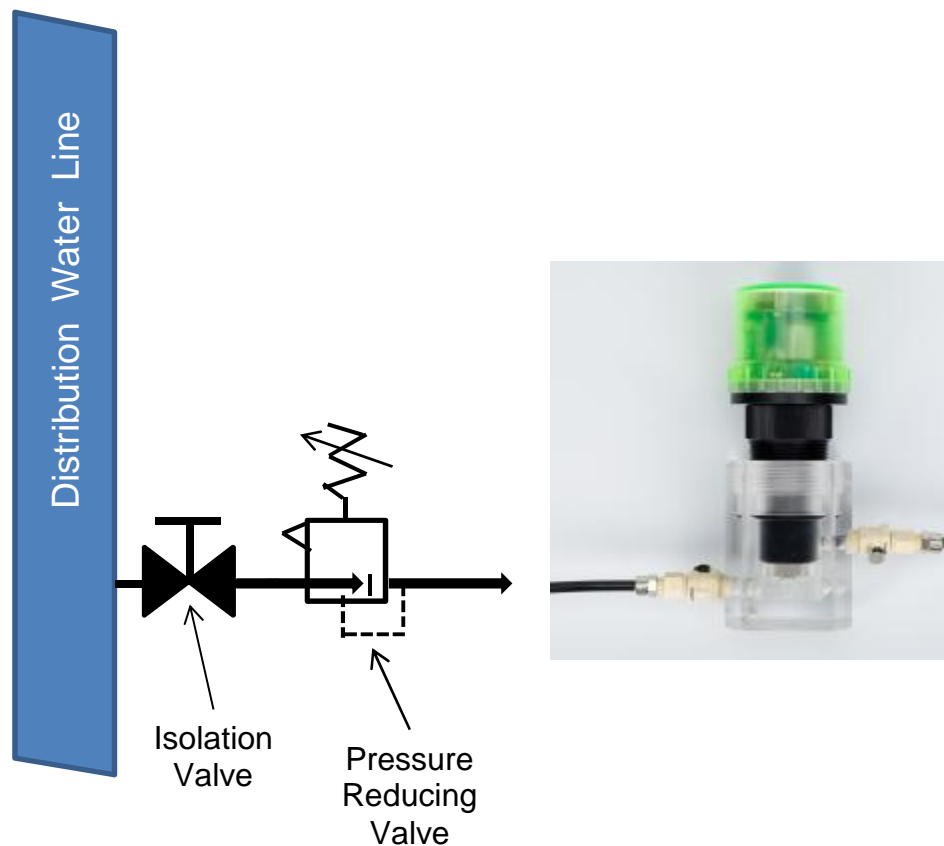

Figure 1 - Typical ChlorLog Monitoring Installation

1.3 ChlorLog System Specifications

Measurement	Free Chlorine
Description	Logging of Free Chlorine in water
Typical Applications	Monitoring of potable water distribution systems to confirm disinfectant residual throughout
Analysis Method	Amperometric (polarographic) membraned sensor
Measurement Range	0.00 – 5.00 ppm
Display Resolution	0.01 ppm
Accuracy	± 0.02 below 1 ppm, ±0.05 above 1 ppm
Repeatability	± 0.02 ppm
Zero Stability	± 0.02 ppm non-cumulative
Data Log Frequency	1 second to 12 hours, programmable
Data Storage	64,000 Measurements
Power	Three Internal ½ AA Lithium cells
Display	3 Digit LCD
Environmental Rating	Nema 6 (IP-68) Submersible
Size	Approx. 8"x3"x3" (200x75x75 mm)

1.4 ChlorLog Sample Requirements

Sample Inlet Pressure	1-60 PSI (0.1-4 bar)
Sample Temperature	1-50° C
Sample pH	pH 5-10
Suspended Solids	Sample filtered to less than 100 microns
Sample Flowrate	Fixed 250 ml/min. (4 GPH)
Inlet Connection	Quick-Connect fitting with valve
Drain Connection	Quick-Connect fitting with valve

Part 2 – Sensor Preparation

2.1 Chlorine Sensor Preparation

The chlorine sensor supplied with the A22 is shipped dry. It will not operate until it is prepared by adding electrolyte and a membrane. Preparation of the sensor for operation must be done carefully. The procedure should be done by a qualified technician, and it should only be done when the system is ready for operation. Until then, it is best to leave the sensor in the condition in which it is received.

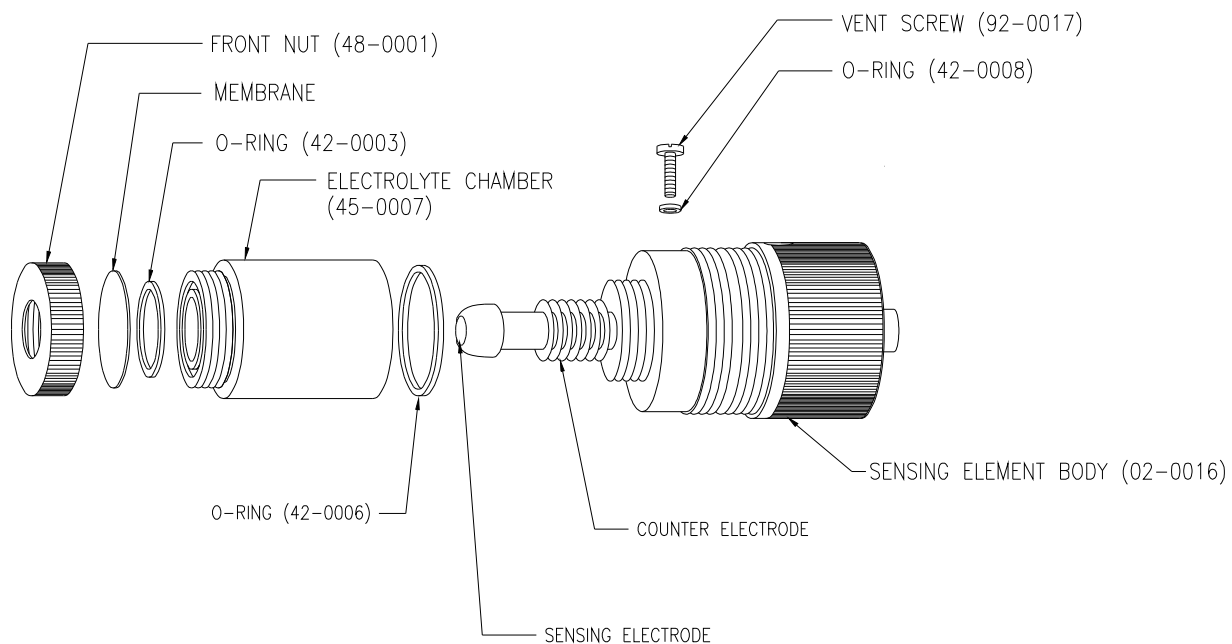

Figure 2 - Cl₂ Sensor Assy (ATI-0294)

Follow the procedure below to prepare the chlorine sensor for operation:

1. Unscrew the electrolyte chamber from the assembled sensor and also remove the vent screw (vent screw) from the side of the sensor body.
2. Remove the front nut from the bottom of the chamber and discard the protective membrane. O-rings are contained in grooves on both the bottom and top of the chamber. Be sure that these o-rings remain in place.
3. From the package of membranes supplied with the sensor, place a new membrane into the front nut. **The membrane is white in color and is separated from other membranes by a light blue paper spacer.**

4. Screw the front nut on to the chamber until you feel the o-ring compress. Hand tight compression is all that is needed. Do not use tools to tighten. The membrane should be flat across the bottom of the chamber without wrinkles.
5. Fill the chamber with electrolyte until the level reaches the bottom of the internal threads.
6. Slowly screw the chamber onto the sensor body. A small amount of electrolyte will run out of the hole from which the vent screw was removed. Place a paper towel around the sensor to absorb the electrolyte overflow. The electrolyte is harmless and will not irritate skin. Tighten the chamber until the o-ring at the top of the chamber is compressed. Once again, do not use tools to tighten.
7. Shake excess electrolyte from the vent hole on the side of the sensor and replace the vent screw.

The sensor is now ready for operation. The membrane should be stretched tightly across the tip of the sensor.

CAUTION: When handling the assembled sensor, do not set the sensor on its tip or damage to the membrane will result. Severe impacts on the tip of the sensor from dropping or other misuse may cause permanent damage to the sensor.

Part 3 – Operation

3.1 General

The ChlorLog is designed to be used virtually anywhere that free chlorine data is desired. The entire device is completely submersible so it can be used in locations that might be subject to flooding. All that's needed is sample connection.

CAUTION: ChlorLog flowcells are suitable for inlet pressure of 0-60 PSIG (0-4 bar). Do not connect the ChlorLog flowcell to sample lines with higher pressures. If sample line pressures are above 60 PSIG, use a pressure reducing valve ahead of the flowcell to reduce sample pressure below 60 PSIG.

3.2 Startup

For operation, ChlorLog sensors are inserted into a clear acrylic flowcell with valved fittings on both the inlet and outlet. **To insert or remove the sensor from the flowcell, the flowcell must be vented.** You will find an L-shaped fitting in the carrying case that will mate with the inlet or outlet fittings on the flowcell. Plug that fitting in to vent the flowcell for sensor removal. Attempting to insert the sensor without venting the flowcell is extremely difficult and may result in distorting the sensor membrane. This would require installing a new membrane and electrolyte.

There are 3 lithium batteries supplied with the ChlorLog. You will note that each battery has some tape on it to form a small tab. When installing the batteries, make sure the tabs are facing out. These are provided to make battery removal easier. Remove the cover from the electronics compartment and install the batteries. The battery holders have + and - markings. Be sure to install each battery as indicated on the holders.

Free chlorine sensors require a few hours to stabilize. Connect your inlet tube to a water source and place your drain tubing into a suitable drain. Plug both inlet and outlet fittings into the flowcell and turn on the sample. Allow the system to run for 4 hours prior to adjustment.

3.3 Calibration

Prior to leaving the ChlorLog to gather data at a specific location, the unit should be calibrated against a known chlorine residual. The easiest way to do this is to connect sample to the flowcell and allow sample to run for 5-10 minutes. After the value on the display is relatively stable, take a sample from the drain line and measure the free chlorine concentration with a colorimetric test kit. **DO NOT CALIBRATE TO VALUES BELOW 0.2 PPM.**

To adjust the value on the ChlorLog, unscrew the green plastic cover so you have access to the adjustment potentiometers. You do not need to adjust the zero pot. Adjust the span pot. using the special screwdriver supplied with the unit until the display matches your test kit result. After adjustment, replace the plastic cover securely to insure water-tight integrity of the electronics compartment.

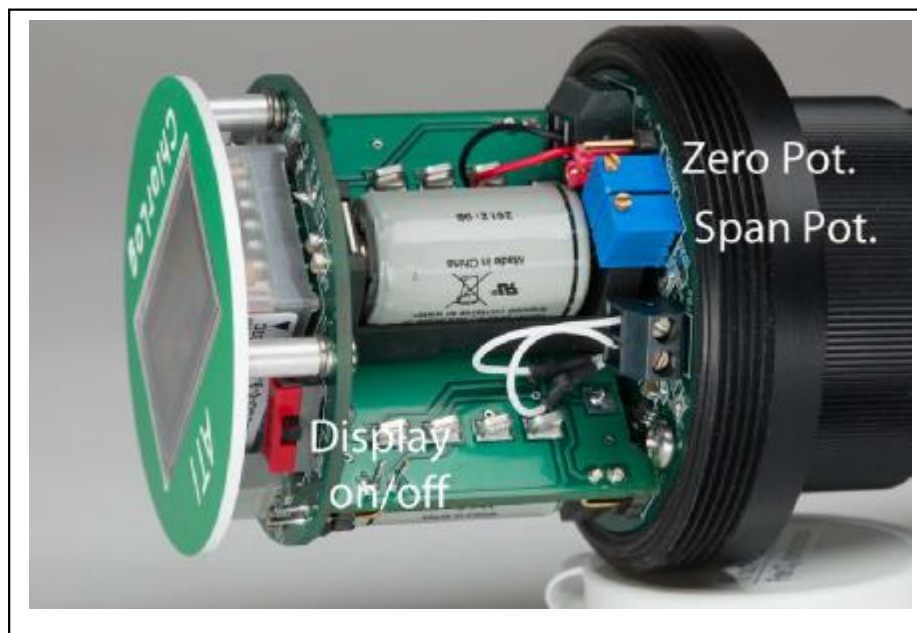

NOTE: When deploying a ChlorLog for long-term data logging, it is important to turn off the LCD display to conserve battery power. The display is by far the largest power consumer and it does not need to be on for the instrument to log data. Leaving the display on will greatly reduce the life of the batteries. A slide switch located as shown in the photo above turns the display on and off.



3.4 Adjusting Zero

As previously mentioned, adjustment of zero is not normally needed as it is set at the factory. However, it is possible that the zero may need to be reset if that pot. is adjusted by mistake. The procedure is a simple one.

Refer to the photo on the previous page. Just above the zero pot. is a 3-pin header with a red jumper installed on the rear two pins. Remove the jumper and install it on the front two pins. Observe the value on the display. If not 0.00, adjust the zero pot. until the display is 0.00 ± 0.01 . Then move the jumper back to the two rear pins.

3.5 pH Effects on Data

Free chlorine sensor response is affected by pH changes in the measured sample. While the pH dependence is relatively small over normal water system variations, using the free chlorine ChlorLog on sample lines where pH varies by more than about ± 0.5 pH units is not recommended. Most water supply systems vary much less than this and it is not a normal problem but users must be aware of possible errors due to wide pH variations.

The chart below provides a graph of the output of a free chlorine sensor vs. pH. For collecting data on systems with widely varying pH conditions, ATI can supply the model PQ45 system that automatically corrects free chlorine measurements for pH variation. Consult the ATI website for further details.

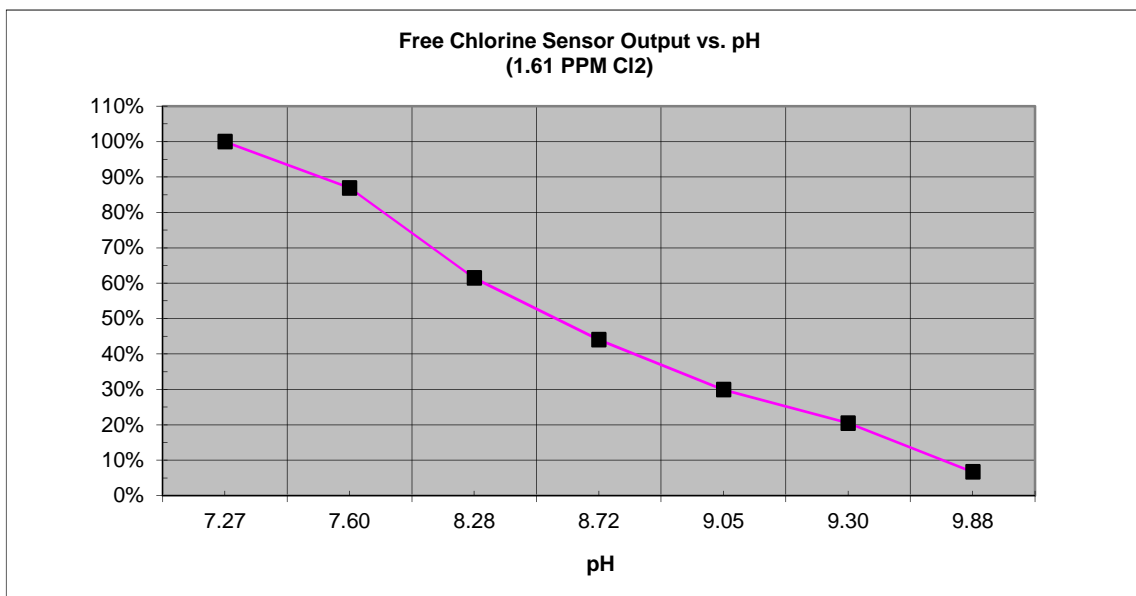

Figure 3 - Typical Free Cl₂ Response to Change in pH

3.6 Flowcell Orientation

Once the ChlorLog is calibrated and ready to deploy, note that the orientation of the flowcell is important. If the unit is installed in a vertical position, it is possible that air will collect under the sensor membrane and cause low readings. The unit should be operated in a horizontal position to avoid this problem.

The photos below show the vertical and horizontal orientations. The unit does not need to be exactly horizontal. Even oriented at 45 degrees to vertical is fine with sample coming in at the lowest point and exiting at the top.



Vertical Position (Wrong)

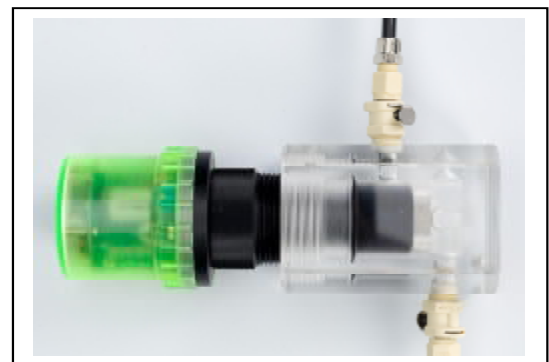

Horizontal or Angled Position
(Correct)



REMEMBER to turn off the display after setting up the ChlorLog for extended data recording.

Part 4 – Data Handling

4.1 General

The ChlorLog is designed to store measurement data over a period of time and transfer the stored data to your computer through a USB port. A USB interface cable is supplied with the unit. One end of the cable is a standard USB plug and the other is a Micro-USB plug. The Micro-USB plug mates with a connector in the ChlorLog.

4.2 Software Download

In order to log and download data, you must install a program on your computer. The program is free and is available at www.lascarelectronics.com.

From the main page, click on Software and then on EasyLog USB. Download the EasyLog USB software and install it on your computer. An EasyLog icon should be installed on your desktop. Once installed, you are ready to configure the ChlorLog for data collection. Note that the Lascar website contains a video explaining how to use the EasyLog USB software.

4.3 Configuring the Logger

To configure the data logging function and start the data logger, remove the cover from the Chlor-Log and plug the USB cable into the connector as shown below. Plug the other end of the cable into the USB port on your computer.



Double click the EasyLog USB icon on your desktop to start the program. The following screen should appear on your computer. Be sure the ChlorLog is connected to the computer with the USB cable.



Click on the “Set up and start the USB data logger” icon. Note that it can sometimes take a few minutes for a computer to recognize the connection with the ChlorLog. If you get a message that no data logger is found, wait for a minute and try again. When communication is established, the following window will appear.



Click OK and the setup screen will appear.

There are 3 sections to this screen. In the top section, you can assign a name to the logger you are programming. Pick whatever name makes sense to you.

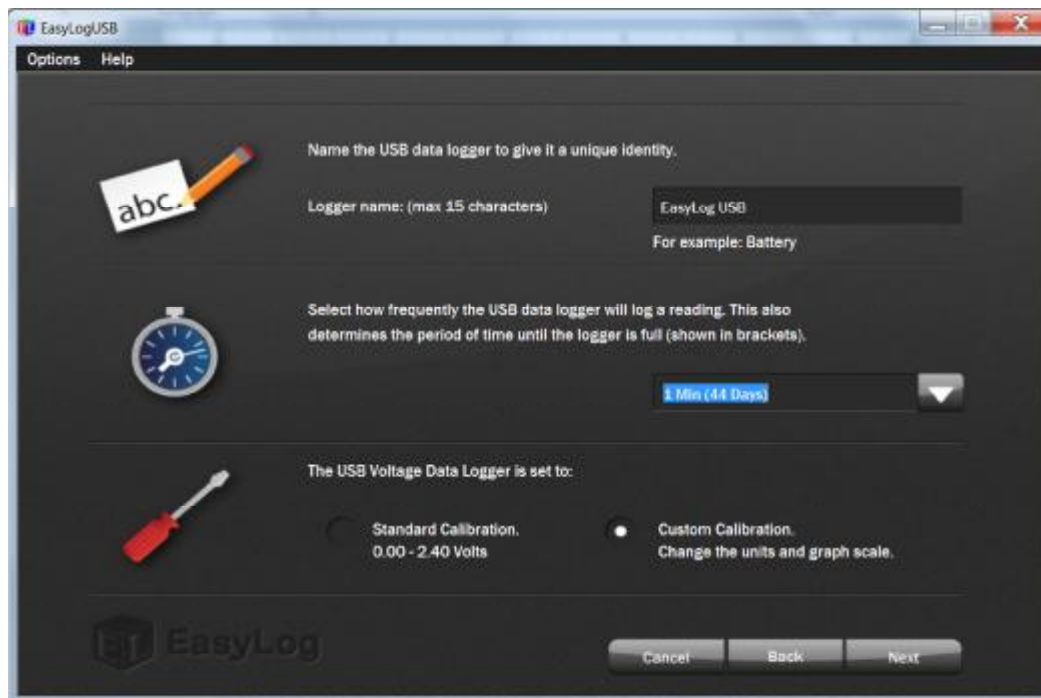

The second section allows you to select the logging interval. Chlorine sensors respond fairly slowly so selecting any frequency greater than 1 minute is not really of great value. The storage interval for each selection is shown. A typical storage interval is 1-5 minutes depending on how long you wish to deploy the unit and how much data you want to handle.

The final section allows you to simply log voltage or set up the unit for a "Custom Calibration". Select Custom Calibration and the click "Next" at the bottom.

This screen allow you to define units of measurement and range. In the units of measurement block, type in “ppm Cl2” or other description you want to use. For the calibration, change the graph output value in line 2 from 2.40 (default value) to 5.00. When finished, click Next.



The next screen to appear is for alarm settings. Alarms are not used in this device and no changes should be made on this screen. Click Next.

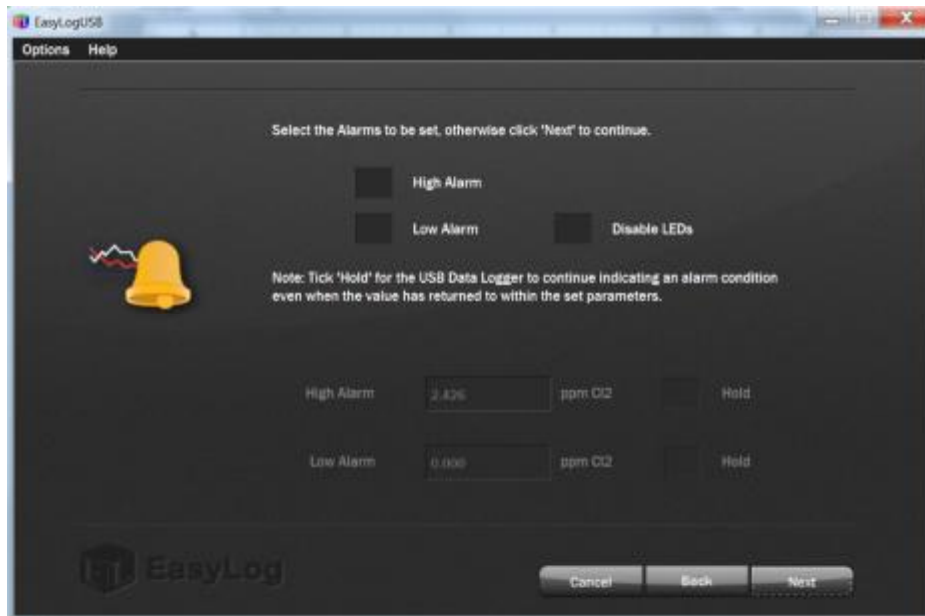

This screen allows you to define what happens when the logger memory is full. You can either stop logging or continue to log, overwriting the oldest data. Make your selection and click Next.



The final screen allows you to start logging immediately or to program a day and time when logging should start. Make your selection and click Finish. A screen will appear indicating that programming was successful and you can unplug the ChlorLog from the computer. When running, you will see a small LED on the ChlorLog flash about every 5 seconds.

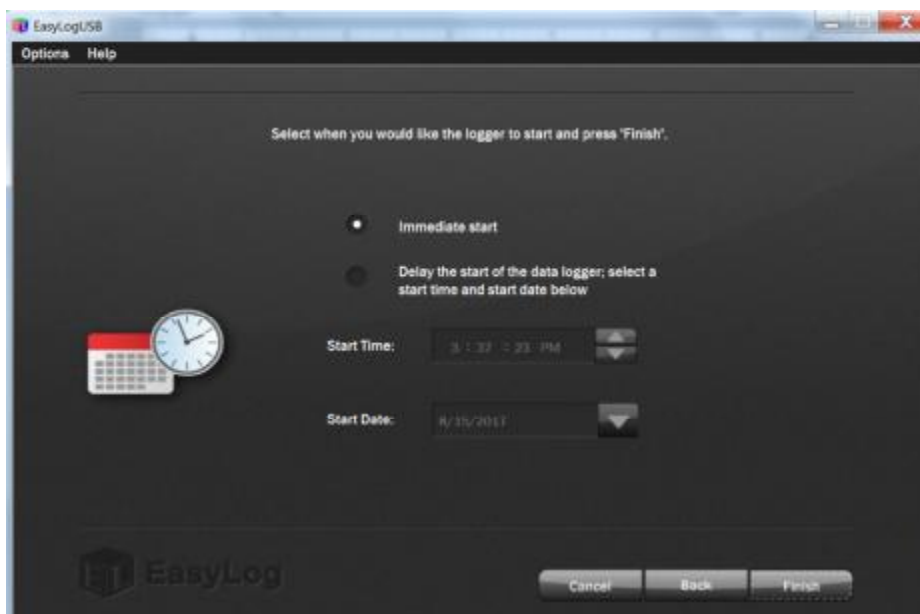

4.4 Downloading Data

Once the logger has been running for a period of time and collected the desired data, you can use the same EasyLog USB software to transfer the stored data from the ChlorLog to your computer. Connect the ChlorLog to your computer as you did during the setup.

From the opening screen of the EasyLog USB software, click on “Stop USB data logger and download data”. You will get a warning message. Click OK and the following screen will be displayed. Click OK to assign a file name. Choose a file name and a storage location that makes sense to you. A file name that provides the storage period is one useful option, like “June2-June14”. After clicking OK, the EasyLog software graphing program will start up and a graph of the downloaded data will be displayed.

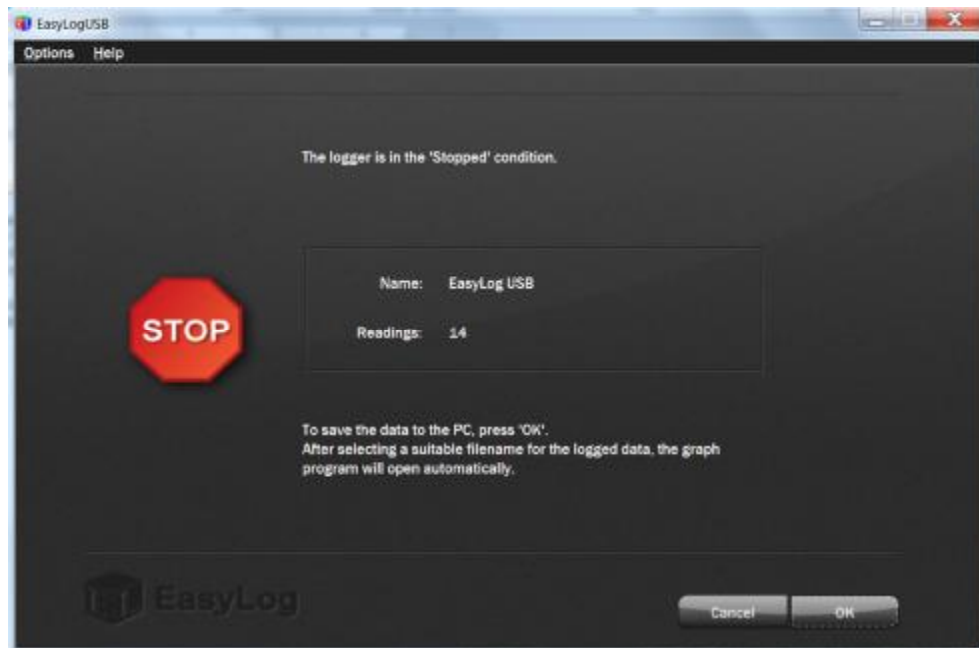

The graphing function and the raw data display is explained in much greater detail on the Lascar Electronics website. From the link below, you have access to video tutorials on downloading and data display functions.

<https://www.lascarelectronics.com/software/easylog-usb/>

Part 5 – Maintenance

5.1 Batteries

The lithium batteries used in the ChlorLog are not rechargeable. When batteries are depleted, it is important that you dispose of the batteries in accordance with all local and national regulations related to this type of device.

Be careful when removing old batteries or installing new ones. Hold the electronic assembly so that you do not put too much stress on the mounting screws. When replacing batteries, a small thin-bladed screwdriver is useful in popping the old batteries out of the holders.



CAUTION: Remove batteries carefully if using tools to avoid possible circuit board damage which is not covered under warranty.

5.2 Sensor Maintenance

The membrane used on the free chlorine sensor can become fouled over time and must be changed periodically. Membranes will normally last between 2 and 6 months. The interval is highly dependent on water quality and the presence of iron or manganese precipitates. Only experience can tell you how often service is needed. However, it is good practice to change the membrane prior to any long deployment. If you plan to log data for 3 or 4 months, it is best to start with a fresh membrane.

Always use the procedure in Part 2 of this manual. Electrolyte will automatically be changed when using this procedure. Never try to change the membrane by removing only the membrane cap. This will not work. The membrane will not be secured properly.

A supply of membranes and electrolyte is provided with the unit. Also supplied is an o-ring kit. Replace all o-rings in the sensor assembly once a year.

5.3 Cover O-ring

An O-ring is used to seal the removable electronics cover. Inspect that o-ring periodically to insure there are no nicks or other damage. Under normal conditions, the entire ChlorLog is submersible provided that the cover is tight. If any damage is noted on the o-ring surface, the o-ring should be replaced. This is not normally needed with reasonable care when the cover is removed.

5.4 Flow Cell Maintenance

The maintenance on the flow cell is simple cleaning. The flow cell is clear to make examination of the condition of the sensor easier without interfering with operations. The flow cell may be cleaned by wiping or by washing with detergents or dilute acids. Do not try to clean with solvents as the acrylic may craze or crack.

Change the o-ring in the flow cell yearly or if any damage is observed. If insertion of the sensor into the flow cell becomes difficult, use silicon grease to lubricate the o-rings that hold the sensor in place. Use only enough grease to provide surface lubrication. Excess grease could foul the sensor membrane.

Part 6 – Troubleshooting

6.1 General

Should problems arise with the ChlorLog, they are likely to be caused by a few simple issues. The table below provides a listing of potential problems and the typical solution.

PROBLEM	POSSIBLE CORRECTION
Display will not come on	Replace one or more of the batteries. Check that batteries are installed with correct polarity. Toggle display switch on/off.
Sensor will not screw into flowcell.	Plug in a sample line fitting to vent the flowcell.
Displayed chlorine value unstable.	Check sensor membrane condition Observe sample flow to insure it is stable. Verify sensor 200 mv. polarization. Check temperature element in sensor.
Cannot calibrate with span potentiometer	Sensor membrane fouled. Replace membrane.
Display indicating negative values	Adjust zero. Zero pot. may have been turned in error. Check batteries. Contact ATI service if problem cannot be corrected.
Sample does not flow through the flowcell	Fixed flow regulator may be fouled. Clean or replace. Valve on an inlet or outlet fitting may be stuck. Replace fitting if necessary.

6.2 Verify Sensor Polarization

The chlorine sensor requires a bias voltage between the two electrodes contained in the sensor body. The electrodes are connected to terminal blocks using black and red wires. Refer to the photo on the next page for a view of the location of those connections.

Using a DVM, measure the mv. value between the red and black wire terminals. Leave the wires connected for the measurement. You should read a bias voltage of 200 mv. \pm 5 mv. between those terminals and the voltage should be very stable.

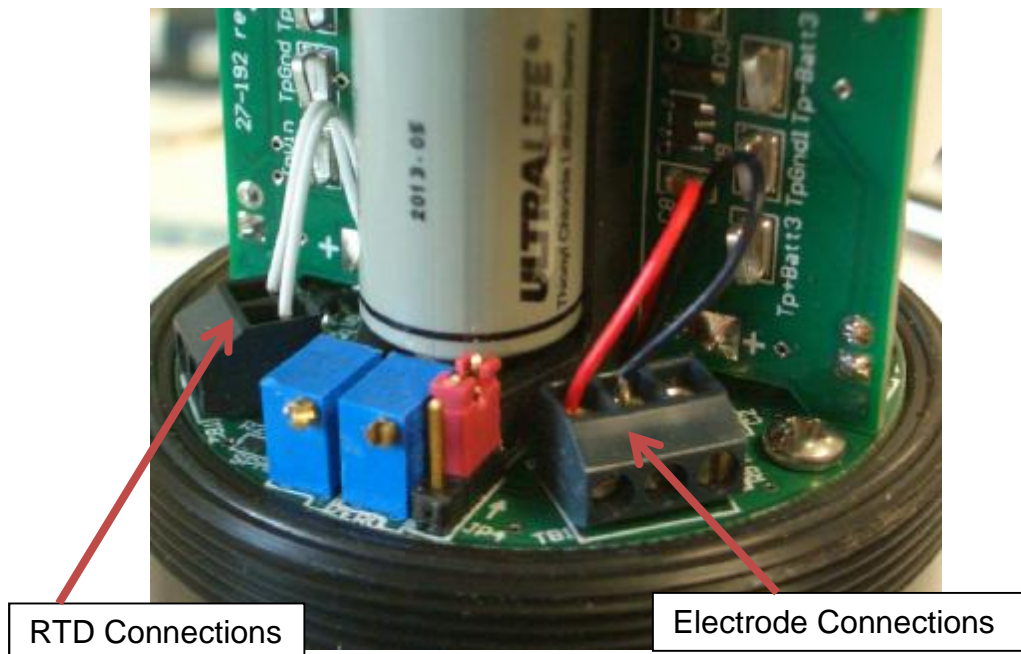

6.3 Verify Temperature Element

While temperature is not displayed on the ChlorLog, a temperature element is located inside the sensor. The Pt100 RTD provide temperature compensation for the chlorine measurement. Failure of the RTD could lead to erratic measurements.

To test the temperature element, it must be disconnected from the circuit. The RTD is connected to the circuit using two white wires as shown in the above photo. Using a small screwdriver, disconnect the two white wires.

Using a DVM, measure the resistance between the two wires. The resistance value will vary depending on the temperature of the sensor. The table on the next page provides resistance values for the RTD at various temperatures. Normally, failure of an RTD results in either an open circuit or a very high resistance value.

Temperature °C	Resistance Ω
0	100.0
5	101.9
10	103.9
15	105.8
20	107.8
25	109.7
30	111.7
35	113.6
40	115.5
45	117.5
50	119.4

Figure 4 - Pt100 RTD Table

6.4 Electrode Leakage Test

Chlorine sensors can be tested with a digital voltmeter (DVM) to determine if a major sensor problem exists. Follow the steps below to verify sensor integrity:

- A. Disconnect both the two white temperature wires and the red and black electrode wires from the electronic assembly.
- B. Remove the electrolyte chamber from the sensor and dry the electrodes with a paper towel.
- C. Connect a DVM between one of the white wires and the red wire. Reading resistance, you should find an open circuit value of infinite resistance. There must be no measurable resistance at all between these wires. Any resistance at all indicates either water in the cable connector or the breakdown in an electrode seal.
- D. Connect a DVM between the red and black wires. With a dry sensor body, you should find an open circuit value of infinite resistance. Any resistance at all indicates the breakdown in an electrode seal.

If the above tests do not confirm open circuit values, the sensor will need to be replaced. This can only be done at ATI. Contact the ATI service department for a return authorization at atiservice@analyticaltechnology.com.

Spare Parts

<u>Part No.</u>	<u>Description</u>
00-1819	ChlorLog sensor/logger assembly
00-1871	ChlorLog flowcell assembly with fittings
02-0243	ChlorLog Sensing Assembly
45-0007	Electrolyte chamber
45-0374	ChlorLog Cover
48-0001	Membrane holder, titanium
05-0005*	Membranes, pkg. of 10
05-0004*	Spare Parts Kit, screw & o-ring
09-0011*	Free chlorine electrolyte, 4 oz (120 cc)
42-0126	Cover O-ring
29-0012	Tadiran ½ AA lithium battery
44-0270	Valved fittings for sample & drain tubing
44-0288	Valved fittings for flowcell
44-0276	Sample/drain tubing, black polyurethane
55-0013	Potentiometer adjustment tool
31-0210	USB to micro-USB cable assembly
90-0032	ChlorLog carrying case

PRODUCT WARRANTY

Analytical Technology, Inc. (Manufacturer) warrants to the Customer that if any part(s) of the Manufacturer's equipment proves to be defective in materials or workmanship within the earlier of 18 months of the date of shipment or 12 months of the date of start-up, such defective parts will be repaired or replaced free of charge. Inspection and repairs to products thought to be defective within the warranty period will be completed at the Manufacturer's facilities in Collegeville, PA. Products on which warranty repairs are required shall be shipped freight prepaid to the Manufacturer. The product(s) will be returned freight prepaid and allowed if it is determined by the manufacturer that the part(s) failed due to defective materials or workmanship.

This warranty does not cover consumable items, batteries, or wear items subject to periodic replacement including lamps and fuses.

Gas sensors carry a 12 months from date of shipment warranty and are subject to inspection for evidence of misuse, abuse, alteration, improper storage, or extended exposure to excessive gas concentrations. Should inspection indicate that sensors have failed due to any of the above, the warranty shall not apply.

The Manufacturer assumes no liability for consequential damages of any kind, and the buyer by acceptance of this equipment will assume all liability for the consequences of its use or misuse by the Customer, his employees, or others. A defect within the meaning of this warranty is any part of any piece of a Manufacturer's product which shall, when such part is capable of being renewed, repaired, or replaced, operate to condemn such piece of equipment.

This warranty is in lieu of all other warranties (including without limiting the generality of the foregoing warranties of merchantability and fitness for a particular purpose), guarantees, obligations or liabilities expressed or implied by the Manufacturer or its representatives and by statute or rule of law.

This warranty is void if the Manufacturer's product(s) has been subject to misuse or abuse, or has not been operated or stored in accordance with instructions, or if the serial number has been removed.

Analytical Technology, Inc. makes no other warranty expressed or implied except as stated above

WATER QUALITY MONITORS

Dissolved Oxygen
Free Chlorine
Combined Chlorine
Total Chlorine
Residual Chlorine Dioxide
Potassium Permanganate
Dissolved Ozone
pH/ORP
Conductivity
Hydrogen Peroxide
Peracetic Acid
Dissolved Sulfide
Residual Sulfite
Fluoride
Dissolved Ammonia
Turbidity
Suspended Solids
Sludge Blanket Level
MetriNet Distribution Monitor

GAS DETECTION PRODUCTS

NH₃ Ammonia
CO Carbon Monoxide
H₂ Hydrogen
NO Nitric Oxide
O₂ Oxygen
CO Cl₂ Phosgene
Br₂ Bromine
Cl₂ Chlorine
ClO₂ Chlorine Dioxide
F₂ Fluorine
I₂ Iodine
H_x Acid Gases
C₂H₄O Ethylene Oxide
C₂H₆O Alcohol
O₃ Ozone
CH₄ Methane
(Combustible Gas)
H₂O₂ Hydrogen Peroxide
HCl Hydrogen Chloride
HCN Hydrogen Cyanide
HF Hydrogen Fluoride
H₂S Hydrogen Sulfide
NO₂ Nitrogen Dioxide
NO_x Oxides of Nitrogen
SO₂ Sulfur Dioxide
H₂Se Hydrogen Selenide
B₂H₆ Diborane
GeH₄ Germane
AsH₃ Arsine
PH₃ Phosphine
SiH₄ Silane
HCHO Formaldehyde
C₂H₄O₃ Peracetic Acid
DMA Dimethylamine