

DIMENSIONAL DRAWING

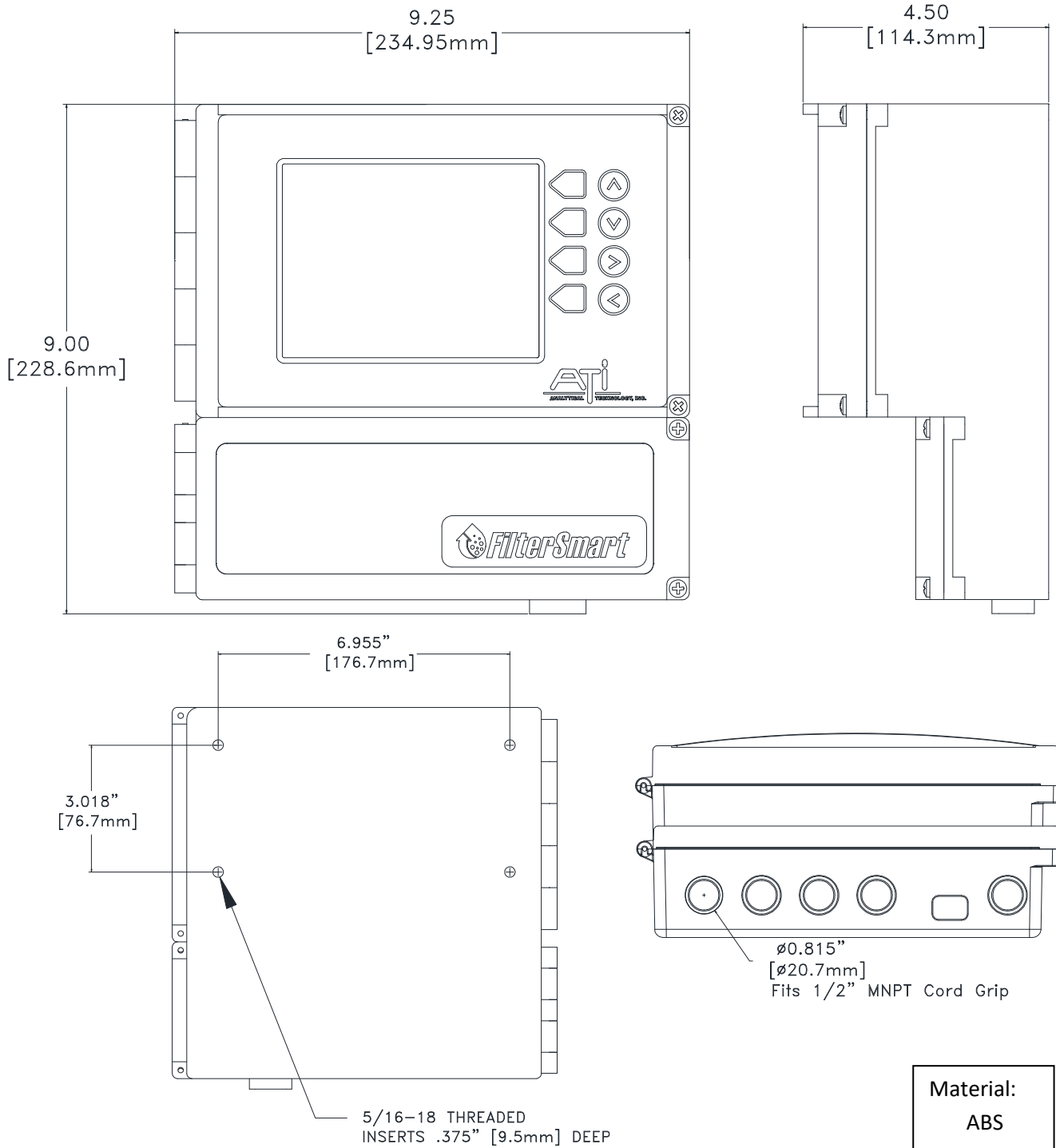

CAUTION: Be very careful when removing the knockouts on the enclosure. A small bladed screwdriver tapped firmly in the knockout recess is all that is necessary. Do not drive the screwdriver blade into the enclosure or it may strike the circuit board and cause component damage.

ELECTRICAL CONNECTIONS

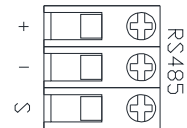
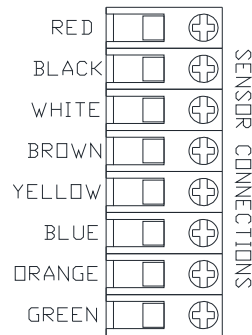
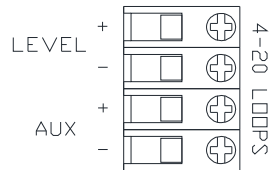
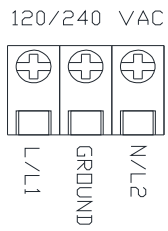
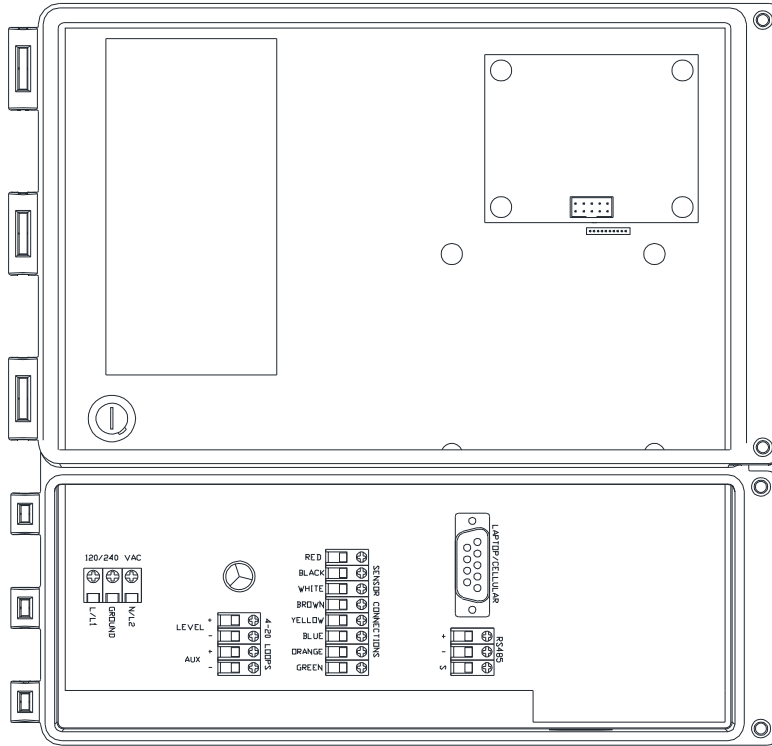

CONFIGURATION OPTIONS

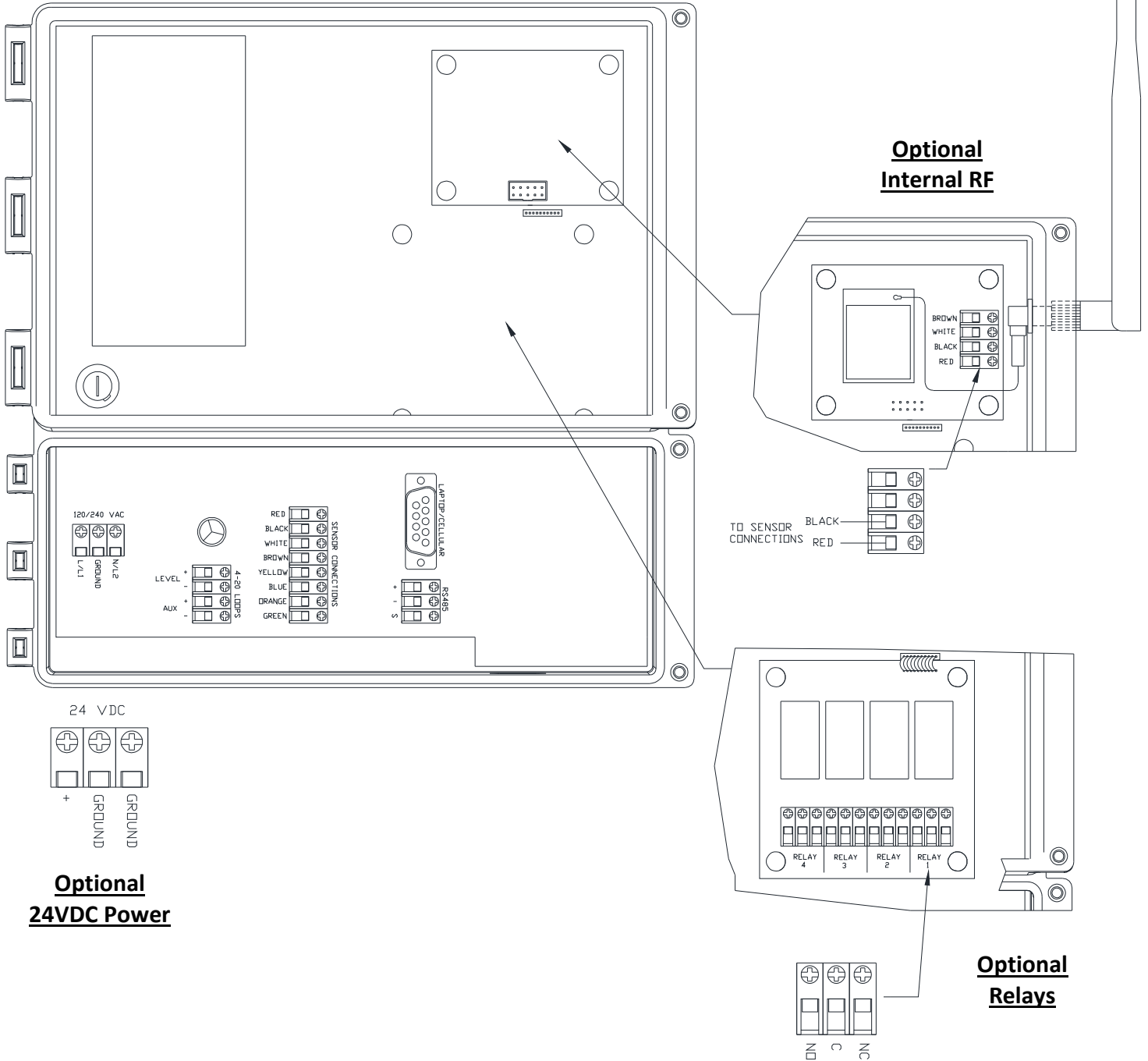

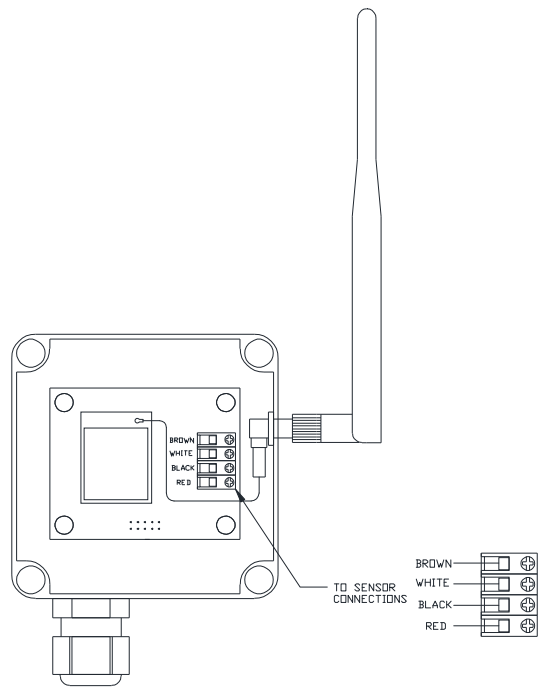
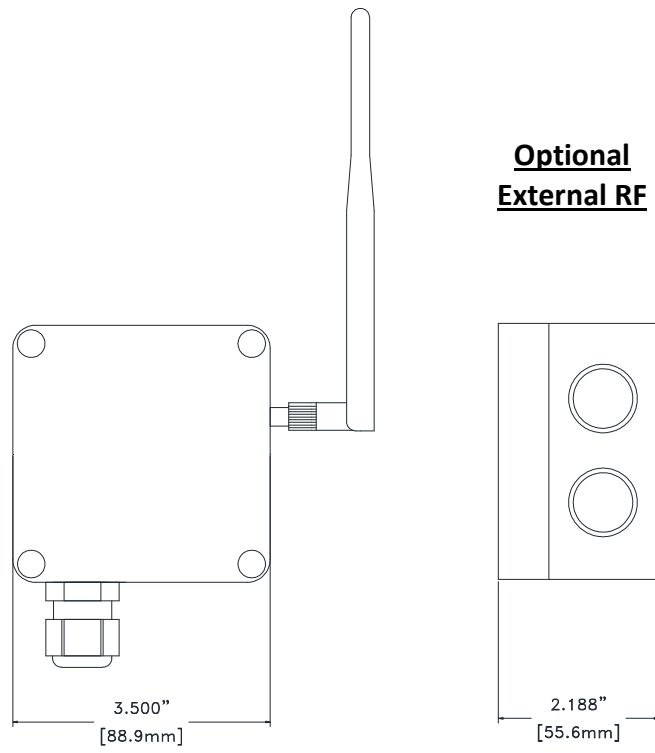

FilterSmart Controller Configurations

Part No.	Power		Network Options			Options
	115/230 VAC	24 VDC	Wired	Internal RF	External RF *	4 Relays
00-1932	•		•			
00-1982	•			•		
00-1983	•				•	
00-1984	•		•			•
00-1985	•			•		•
00-1986	•				•	•
00-1933		•	•			
00-1987		•		•		
00-1988		•			•	
00-1989		•	•			•
00-1990		•		•		•
00-1991		•			•	•

* Cable length between enclosures must be specified.